

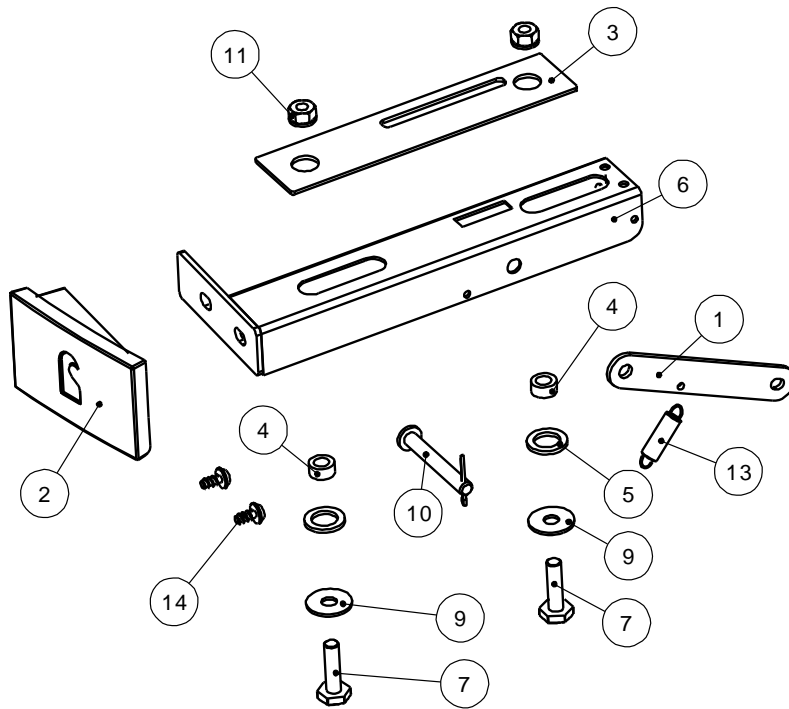

Issue A



Item	Part No.	Description	Ex.Vat.	Inc.Vat.	Item	Part No.	Description	Ex.Vat.	Inc.Vat.
1	010/KS033	Ash Flap Link	11.50	13.80	8*	008/FFW007	Washer 15x8.5	0.10	0.12
2	008/ES15/01	Slide Handle	12.30	14.76	9	008/FFW005	Washer 25x8	0.10	0.12
3	008/KS130	PTFE Handle Slider	12.50	15.00	10	008/FFP008	Clevis Pin 8mm Dia x 60	2.50	3.00
4	008/ES15/09	Spacer	5.10	6.12	11	008/FFN003	M8 Nut	0.30	0.36
5	008/ES15/10	Slide/Spacer	2.45	2.94	12*	008/FFP009	Cotterpin 1.6mm Dia x 25	0.50	0.60
6	010/KS133	Slider Sub-Assy	25.50	30.60	13	008/FFM044	Extension Spring LE026D04	2.45	2.94
7	008/FFS059	Bolt M8 x 20	0.30	0.36	14	008/FFS044	M6x12 Pan Flange TX Screw	0.15	0.18

* These items are not shown on the drawing Prices are shown in pounds sterling with vat at 20% They are correct at the date shown but may be subject to change without notice. E. & O.E These prices will be subject to a carriage charge.

To obtain spare parts please contact your local stockist giving Model, Part No. and Description. In case of difficulty contact the manufacturer at the address shown. This drawing is for identification purposes only.

